

9

SPARE PARTS KIT / RESERVDLAR SOM DELAR / ERSATZTEIL-SET / JEU DE PIÈCES

O-ring Kit 143017, 561-15PN and 561-18PN

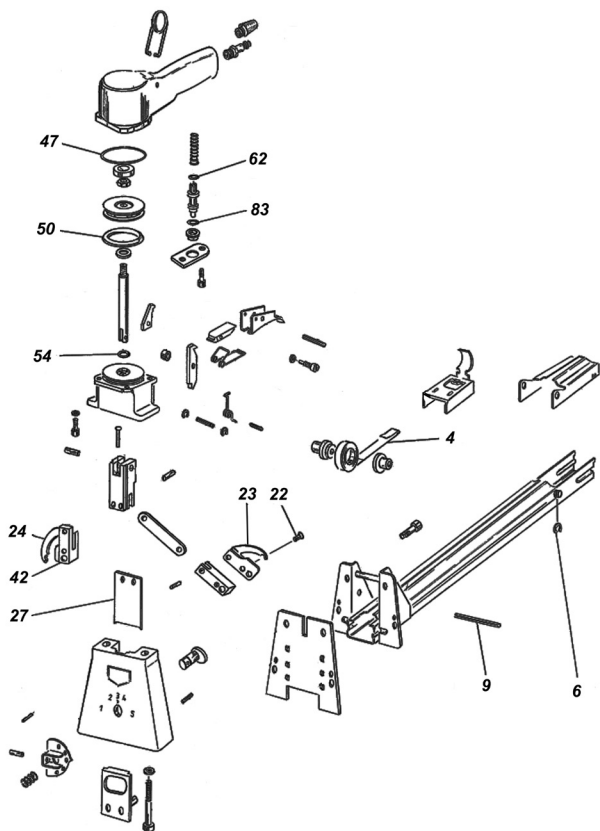

Pos.	Part No. Artikelnr.	Part Name	Benämning	Antal Qty.
47	972002	O-ring	O-ring	1
50	972017	O-ring	O-ring	1
54	972142	O-ring	O-ring	2
62	972009	O-ring	O-ring	2
83	972020	O-ring	O-ring	1
	184943	O-ring grease	JK silicon compoud	1

Repair Kit 143018, only for 561-15PN

Pos.	Part No. Artikelnr.	Part Name	Benämning	Antal Qty.
4	174021	Feed spring	Frammatarfjäder	1
6	951035	Safety ring	Axelsäkring	2
9	945022	Pin	Drivare	1
22	946518	Screw	Skruv	2
23	158038	Anvil left	Klo vänster	2
24	158037	Anvil right	Klo höger	2
27	164023	Driver blade	Drivare	2
47	972002	O-ring	O-ring	1
50	972017	O-ring	O-ring	1
54	972142	O-ring	O-ring	2
62	972009	O-ring	O-ring	2
83	972020	O-ring	O-ring	1
	184943	O-ring grease	JK silicon compound	1

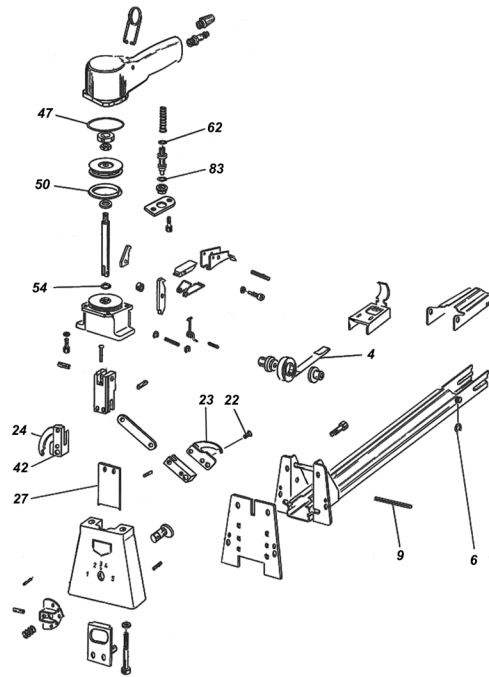

10

		Parts list 561-15PN	561-15PN	561-15PN	
		When ordering please indicate part number	Vid beställning var vänlig ange artikelnummerna	Bei Bestellungen immer Artikel-Nr. angeben	
1	139044	Magazine breech cpl.	Slutstycke kompl.	Magazin-Verschluss	1
3	133161	Pusher 561-15	Frammatare 561-15	Klammerschieber 561-15	1
4	174021	Feed spring	Frammatarfjäder	Zugband	1
5	150071	Roller	Fjäderdistans	Führungsrollen am Zugband	1
6	951035	Retainer	Axelsäkring	Seegerring	1
7	946591	Screw	Skruv	Schraube	4
8	132713	Rail 561-15	Klammerbana 561-15	Magazinführungsblech 561-15	1
9	945022	Tension pin	Spännstift	Spannstift	1
11	945016	Tension pin	Spännstift	Spannstift	1
12	163211	Penetration eccentric	Excenter	Exzenter	1
13	134055	Pivot block for anvil holder	Klobärarfäste	Führungsblock fü Umbieger	1
14	946516	Screw	Skruv	Schraube	1
15	947013	Washer	Bricka	Unterlegscheibe	1
16	155100	Lower body	Hus	Unteres Gehäuse	1
17	945009	Tension pin	Spännstift	Spannstift	1
18	945036	Tension pin	Spännstift	Spannstift	1
20	165054	Penetration control knob	Ställvred	Knopf für Tiefeneinstellung	1
21	173063	Spring	Fjäder	Feder	1
22	946518	Screw	Skruv	Schraube	2
* 23	158038	Anvil hook left 15mm	Klo vänster 15mm	Rillplatte 15mm	1
24	158137	Anvil hook right 15mm	Klo höger 15mm	Rillplatte 15mm	1
25	156119	Anvil holder	Klobärare	Umbiegerhalterung	1
26	945006	Pin	Cylinderpinne	Stift	2
27	164023	Driver blade 15mm	Drivare 15mm	Treiber 15mm	1
28	163133	Anvil link	Nedre länk	Umbiegerhebel	2
29	945016	Tension pin	Spännstift	Spannstift	2
* 30	161055	Connecting yoke	Ok	Verbindungsblock	1
41	132716	Magazine 561-15mm	Klammermagasin 561-15mm	Klammermagazin 561-15mm	1
42	156119	Anvil holder	Klobärare	Umbiegerhalterung	1
45	987023	Nipple	Nippel	Nippel	1
46	136112	Cylinder body	Cylinderdel	Zylinderhäuse	1
47	972002	O-ring	O-ring	O-ring	1
48	946004	Nut	Mutter	Mutter	1
49	191013	Piston	Kolv	Kolben	1
50	972017	O-ring	O-ring	O-ring	2
51	947015	Washer	Bricka	Unterlegscheibe	1
52	191113	Piston rod	Kolvstång	Kolbenstange	1
53	163109	Release latch	Utlösare	Auslösehebel	1
54	972142	O-ring	O-ring	O-ring	1
55	139455	Cylinder chassis	Cylinderfäste	Zylinder-Unterteil	1
56	946662	Screw	Skruv	Schraube	4
57	145049	Pin	Tryckare	Stift	1
58	161054	Connecting yoke	Ok	Verbindungsblock	1
59	945018	Tensioning pin	Spännstift	Spannstift	1
60	149057	Piston stop	Kolvdämpare	Kolbendämpfer	1
61	173055	Valve spring	Ventilfjäder	Ventil-Druckfeder	1
62	972009	O-ring	O-ring	O-ring	2
63	191115	Piston valve	Spindel	Ventilkolben	1
64	147079	Washer	Spindelbricka	Scheibe	1
65	946608	Screw	Skruv	Schraube	2
66	150338	Bushing	Bussning	Buchse	1
67	163298	Toggle latch	Vippspärr	Auslösehebel	1
68	173149	Spring	Fjäder	Feder	1
69	145165	Pin	Pinne	Stift	1
70	947032	Lock washer	Låsbricka	Zahnscheibe	5
71	173049	Return spring	Retur fjäder	Ruckzugfeder	1
72	163152	Valve stem toggle	Vippa	Äöatte für Auslösehebel	1
73	165028	Trigger	Avtryckare	Auslösehebel	1

* Recommended wear parts

* Rekommenderade slitdelar

* Empfohlene Verschleissteile

Pos.	Part No. Artikelnr. Artikel-Nr.	Part Name	Benämning	Benennung	Quantity Antal Stückzahl
74	945011	Tensioning pin	Spännstift	Spannstift	1
75	146061	Screw	Skruv	Schraube	1
76	170515	Hook	Lyftögla	Aufhänger	1
77	161039	Back plate	Kuliss	Hintere Gehäuseplatte	1
78	945022	Tensioning pin	Spännstift	Spannstift	1
79	945015	Pin	Pinne	Stift	1
80	947001	Lock washer	Fjäderbricka	Federring	2
81	971004	Sound absorber	Ljuddämpare	Schalldämpfer	1
82	178021	Bushing	Bussning	Buche	1
83	972020	O-ring	O-ring	O-Ring	1
84	951020	Clips	Spårring	Sicherung	2

* Recommended wear parts

* Rekommenderade slitdelar

* Empfohlene Verschleissteile

